

inserto in gommapiuma con logo

INSERIRE PANNELLO IN COMPENSATO sp 6mm

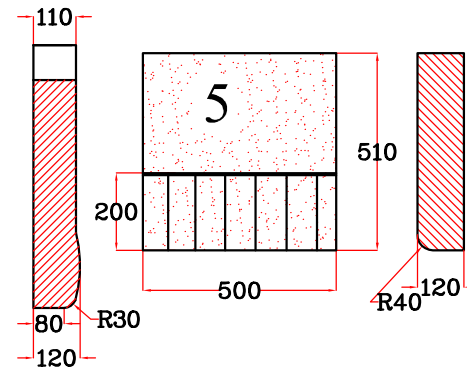

Realizzare n° 2 pezzi

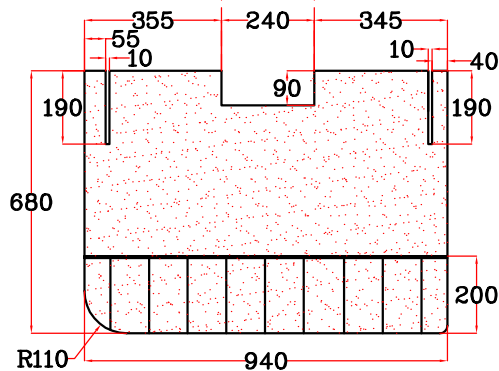
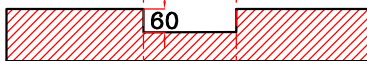
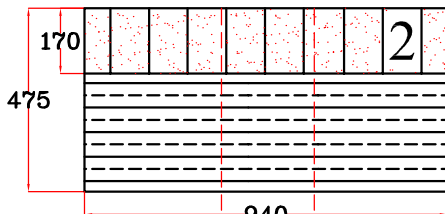
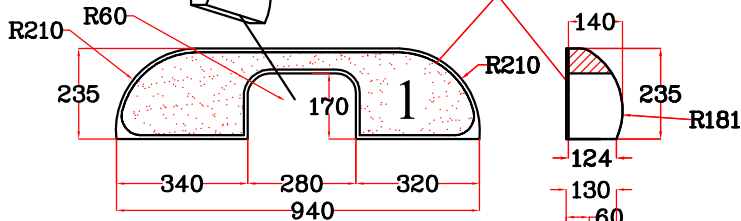
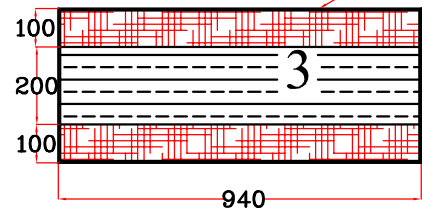

Eeguire i due jolly A e B in Pelkø 189 sp. 120mm

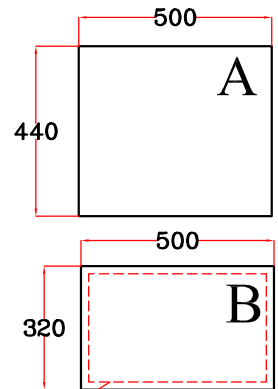

Con pannello multistrato togliere lo spessore del pannello alla gommapiuma

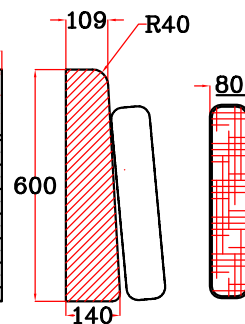
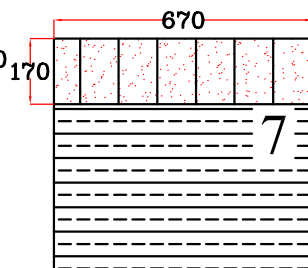
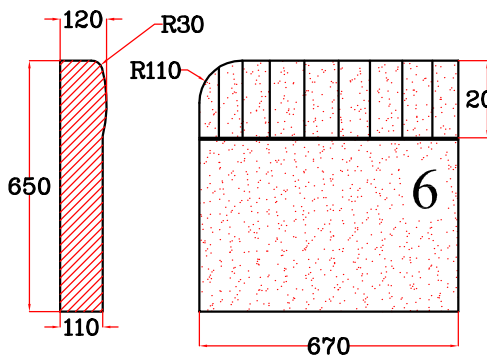

AUTOCARAVANS

RIMOR S.P.A.

SEDE Via Piemonte n°3
53036 Poggibonsi SIENA ITALY

TOLLERANZE DI MASSIMA
Grado di precisione medio
UNI 5307

PAG 1 di 1

Denominazione

Cuscini Super Brig 695 TC

Caratteristiche gommapiuma
Densita' 25 Kg/m³

Caratteristiche gommapiuma schienali
Densita' 25 Kg/m³

Produzione
2014-2015

Meccanica
RENAULT

NOTE Le dimensioni sono riferite al
cuscino finito

Codice

1TAP090285

Codice lavorazione

Rev 01 Data 29-07-2015

Disegnato M.Montegrossi

Data 29-07-2015

Approvato M.Montegrossi

Data 29-07-2015

01
Rev

Modificato posizione scasso seduta frontemarcia
MODIFICA

07-09-2015
Data

A.PINZUTI
ESEGUITA

I dati e le informazioni contenuti o ricavabili da questo disegno sono di esclusiva proprietà della Autocaravans RIMOR s.p.a.
Ogni riproduzione totale o parziale è vietata senza l'autorizzazione scritta della ditta RIMOR s.p.a.



A4